

CORPORATE BROCHURE

# HYUNDAI SUNGWO SOLITE



EXPANDING OUR STAR



# HYUNDAI SUNGWOOLITE

## OVERVIEW

CHAIRMAN'S MESSAGE	03
VISION & PHILOSOPHY	04
JOURNEY of HYUNDAI SUNGWOOLITE	05
COMPANY ORGANIZATION	07
SALES & PARTNERS	09

## CORE COMPETENCE

AUTOMOTIVE & COMMERCIAL BATTERIES	13
INDUSTRIAL & MARINE/RV BATTERIES	15
MANUFACTURING PROCESS	17
RESEARCH & DEVELOPMENT	21
MOTORSPORTS	23

# EXPANDING OUR STAR

A bigger stage awaits Hyundai Sungwoo Solite.  
We make new history with devotion for a greater tomorrow,  
Driven by our vision and dedication for the future,  
we will leap forward as a shining star of innovation  
in the global automotive battery market.

# CHAIRMAN'S MESSAGE

**Committed to the fundamentals, we will continue to challenge and innovate for greater customer satisfaction.**

**Integrity is our Priority**

Evolved from Kyungwon Industry Co. Ltd., established in 1979, Hyundai Sungwoo Solite has been growing by leaps and bounds as a global producer of technology-intensive battery products.

In today's global era, Hyundai Sungwoo Solite's overriding proposition is to 'stick with the basics'. We believe conquering challenges and delivering customer satisfaction derive from two fundamental basics - quality and trust. Hyundai Sungwoo Solite will continue to commit these priorities in order to maximize customer satisfaction with technologically advanced products and solidify corporate reputation as a trusted high-performance leader.

**We Promise a Better Future**

Having achieved consistent and robust growth both in manufacturing capacity as well as quality through technological advancement and sales growth since inception, Hyundai Sungwoo Solite is preparing another leap forward for a 'better tomorrow' in today's business of mobility.

With societies on the brink of the 4th industrial revolution, change and innovation are no longer an option but a necessity. In the midst of rapidly changing paradigms, Hyundai Sungwoo Solite aims to focus on developing cutting-edge technologies and pioneering new businesses. We will closely observe the fast-changing markets and answer customer needs to enable them not only to adapt to the rapidly changing business environment but also to lead change. Our efforts to transform ourselves to lead the future market and to infuse value into mobility lifestyle will push as forward.

**'We' Before 'Me' - We Believe in Growing Together**

Hyundai Sungwoo Solite fulfills social responsibilities with deep care to promote respect for humanity. As a global corporation, we pursue sustainable growth through environmentally-conscious ethical management, and win-win labor management based on cooperation. We envision growing together by creating economic and social values in connection with local communities and the nation as a whole.

It is our aim to uphold our promise for continued growth as well as to challenge ourselves as a company so that we make positive influence on our customers, businesses, local and national communities, and the global village. Thank you.

Hyundai Sungwoo Solite Co., Ltd.

**Chairman Chung, Mong Yong**

# VISION & PHILOSOPHY

**Corporate philosophy rooted in respect for humanity. Mission to satisfy the needs of customers. With our vision and philosophy, we will further enrich lives and enhance technologies.**

**MISSION - Pioneering New Technologies & New Business Opportunities**

Having established a solid foundation overtime, Hyundai Sungwoo Solite has become one of the world's leading automotive parts maker supported by its challenging spirit and respect for humanity. Beyond mere profit, we look for value in technology. It is of utmost concern that our technology is beneficial to the lives of human-beings and that we expand our best efforts to provide customers with products and services that move the hearts of people and exceed expectations.

**PHILOSOPHY - Creating New Values**

Hyundai Sungwoo Solite realizes customer satisfaction with a spirit of challenge and effective talent management. We develop innovative technologies that benefit humans and the environment alike, and through those technologies make products that create new values of happiness and prosperity. Albeit unseen, our philosophies form the solid foundation of our corporation and are infused in Hyundai Sungwoo Solite's technologies and products.

**VISION - Be the One Automotive Company**

Hyundai Sungwoo Solite envisions a tomorrow of togetherness. In pursuit of customer safety and convenience, we will constantly break new grounds and become a major contributor to the world's automotive industry sector. And on our journey, we will make sure technologies become more valued, and lives become more prosperous.

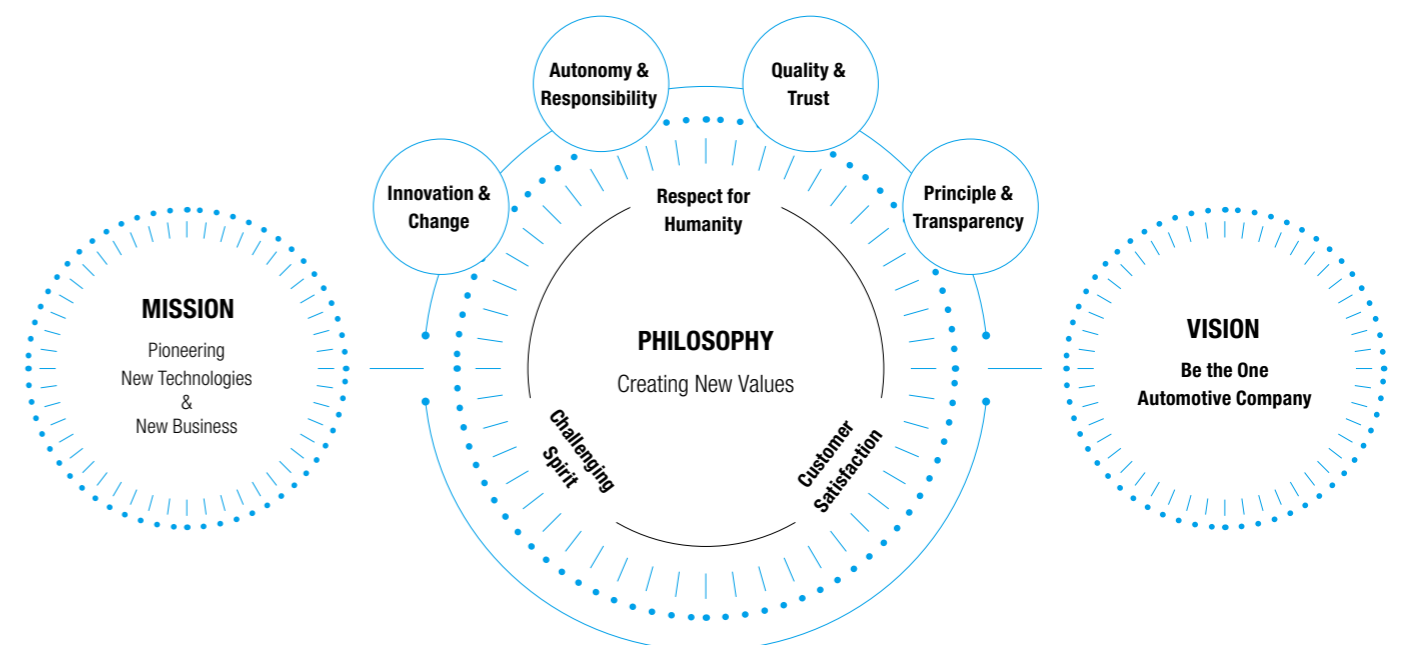

# JOURNEY of HYUNDAI SUNGWO SOLITE

Hyundai Sungwoo Solite has undergone constant change and innovation to become a leading automotive parts manufacturer today. We will continue our journey of persistent growth by taking on bigger and newer challenges.

## 1979~1999

- 1979.02 · Established Kyungwon Industry Co., Ltd.
- 1981.02 · Started business with Hyundai Motor Company
- 1982.06 · Acquired KS certification for automotive lead-acid batteries
- 1987.11 · Awarded the '\$10 million Export Tower Award'
- 1992.08 · Established Central Technology Research Center
- 1993.11 · Jointly developed storage batteries for electric vehicles (Technical partnership with Ovonic)
- 1993.12 · Expanded manufacturing facility to a capacity of 5 million units per year
- 1994.11 · Acquired ISO 9001 certification
- 1994.12 · Acquired UL certification for maintenance-free stationary lead-acid batteries
- 1995.10 · Acquired KS certification for maintenance-free stationary lead-acid batteries
- 1997.11 · Constructed battery plant in Gyeongju
- 1999.01 · Acquired HQS 9002 certification (Hyundai Motor Company)

## 2000~2009

- 2000.01 · Renamed as Hyundai Enercell Co., Ltd.
- 2000.06 · Established Sungwoo USA Corp. (Currently, Hyundai Sungwoo Auto USA Corp.)
- 2000.10 · Acquired QS 9000 certification
- 2001.05 · Started assembly and mass-production of lead-acid battery for forklifts (Agricultural Battery)
- 2003.10 · Acquired ISO/TS 16949 quality system certification  
· Acquired ISO14001 environmental system certification
- 2005.03 · Completed development of NI-MH batteries for defense industries
- 2008.07 · Qualified as Hyundai/Kia's primary supplier with 4.5 STAR quality assurance rating
- 2009.01 · Merged into Sungwoo Automotive Co., Ltd.

## 2010~2020

- 2010.01 · Acquired certificate of Korea Eco-Label for Gyeongju Plant
- 2011.04 · Established Tokyo branch
- 2012.04 · Expanded manufacturing facility to annual production capacity of 6.6 million units
- 2013.05 · Renamed as Hyundai Sungwoo Automotive Korea Co., Ltd.
- 2015.02 · Constructed Research Office Building
- 2015.03 · Expanded manufacturing facility to annual production capacity of 7.3 million units  
· Awarded 'The Greatest Executive Leadership of the Year' in sustainable management for 2 consecutive years presented by Joongang Ilbo
- 2015.05 · Renamed as Hyundai Sungwoo Solite Co., Ltd.
- 2015.09 · Established Hyundai Sungwoo Advanced Materials Co., Ltd.
- 2016.07 · Solite Battery awarded 'The Proud the Most Valuable Product' for 3 consecutive years presented by KMA
- 2019.04 · Awarded 'Kotler Awards' in marketing excellence for sports marketing regarding Solite Indigo Racing presented by Donga Ilbo
- 2021.08 · Solite Battery Awarded 'Brand of the Year 2021' in automotive battery presented by Korea Consumer Forum for 2 consecutive years
- 2022.03 · Solite Battery Awarded 'Korea's No.1 for Brand Value' in automotive battery category for 4 consecutive years

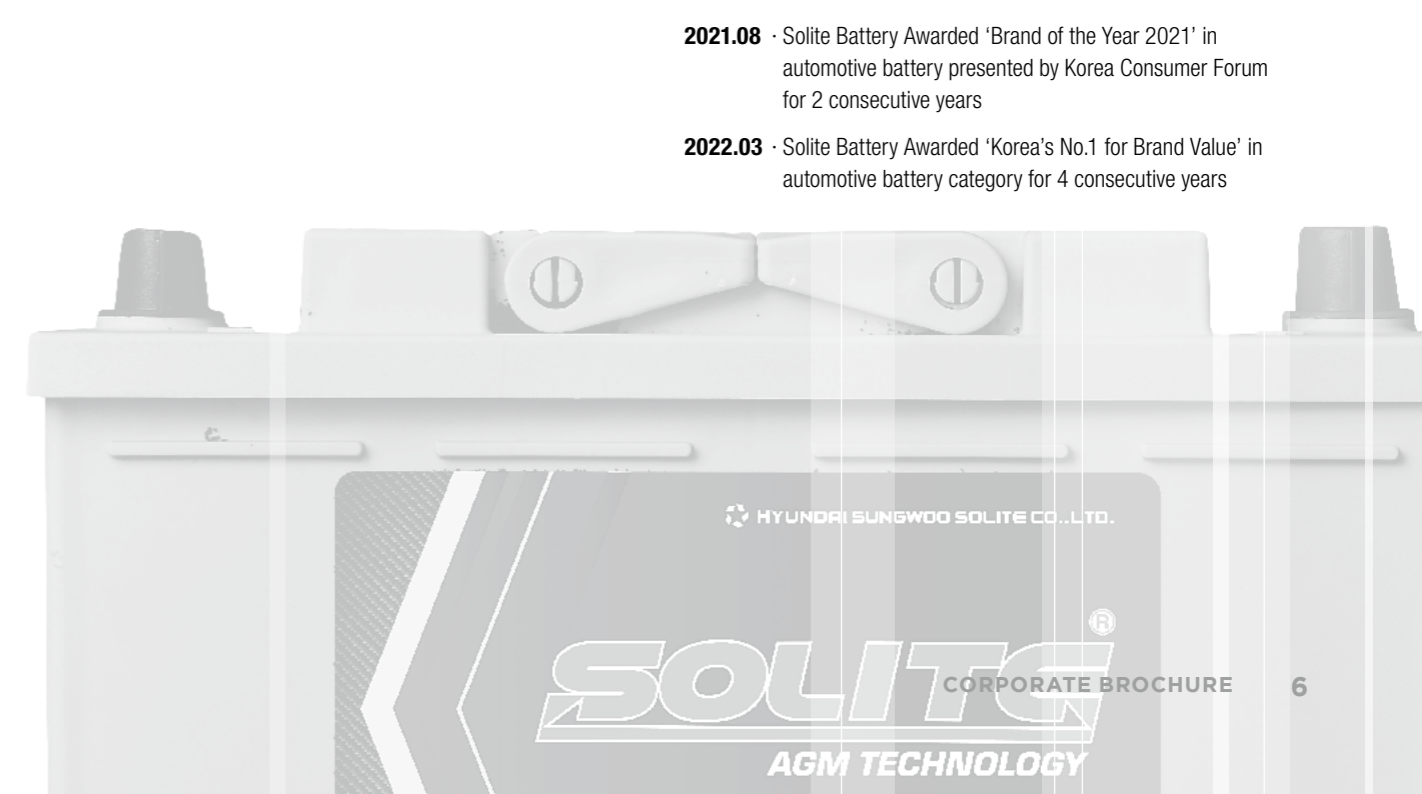

# COMPANY ORGANIZATION

Based on the spirit of innovation and challenge, each business division seeks expansion. With the best talents in every field, we pursue innovation and growth.

Hyundai Sungwoo Solite actively responds to rapidly changing external environments and fosters global competitiveness with a flexible work culture. In step with technological innovations, business divisions organically cooperate to overcome challenges and increase competitiveness.

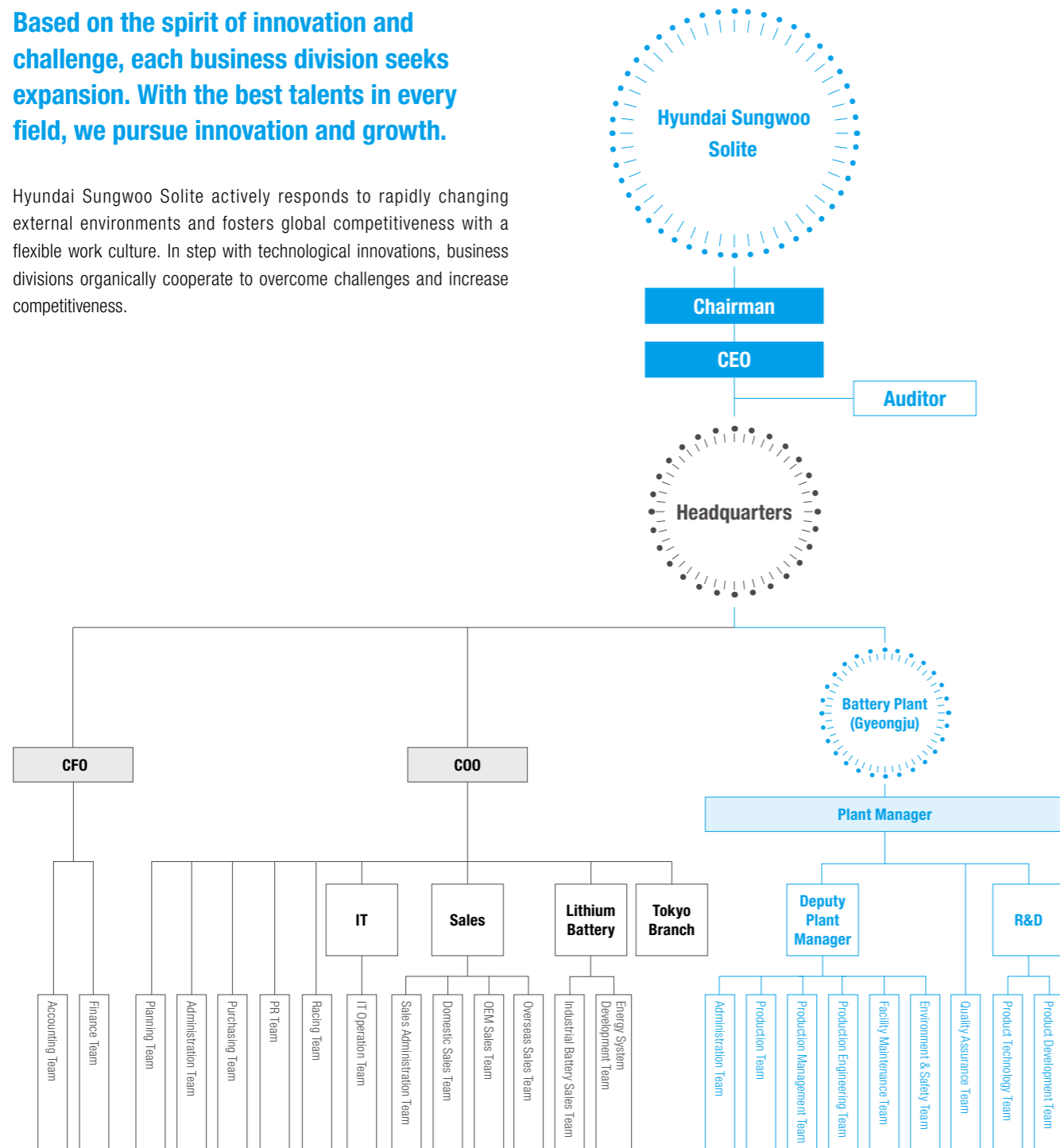

## Domestic Offices



**Hyundai Sungwoo Solite (Headquarters)**

Hyundai Sungwoo Holdings Building, 609 Bongeunsa-ro (Samseong-dong), Gangnam-gu, Seoul South Korea



**Hyundai Sungwoo Solite (Gyeongju Plant)**

200 Yongmyeonggongdan-gil, Guncheon-eup, Gyeongju-si, Gyeongsangbuk-do South Korea

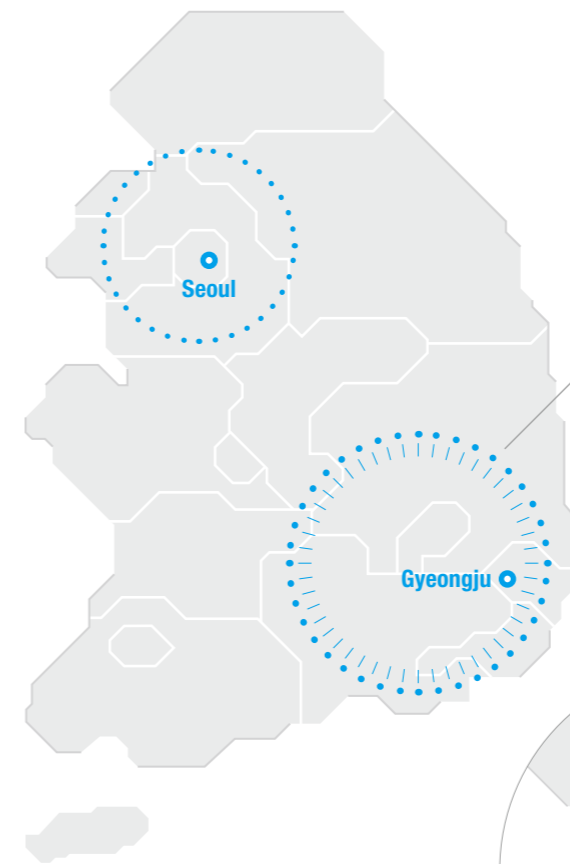

## Overseas Branch



**USA**  
**Hyundai Sungwoo Auto USA**



**Japan**  
**Hyundai Sungwoo Tokyo Branch**



**Hyundai Sungwoo Auto USA**

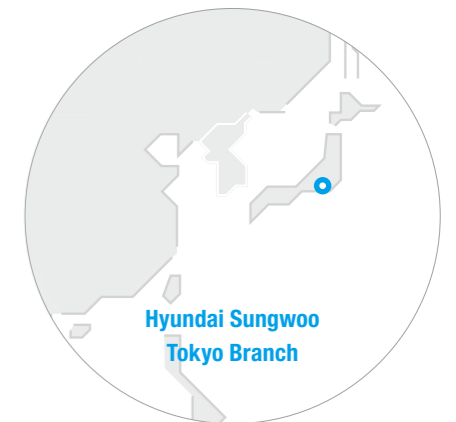

**Hyundai Sungwoo Tokyo Branch**

# SALES & PARTNERS

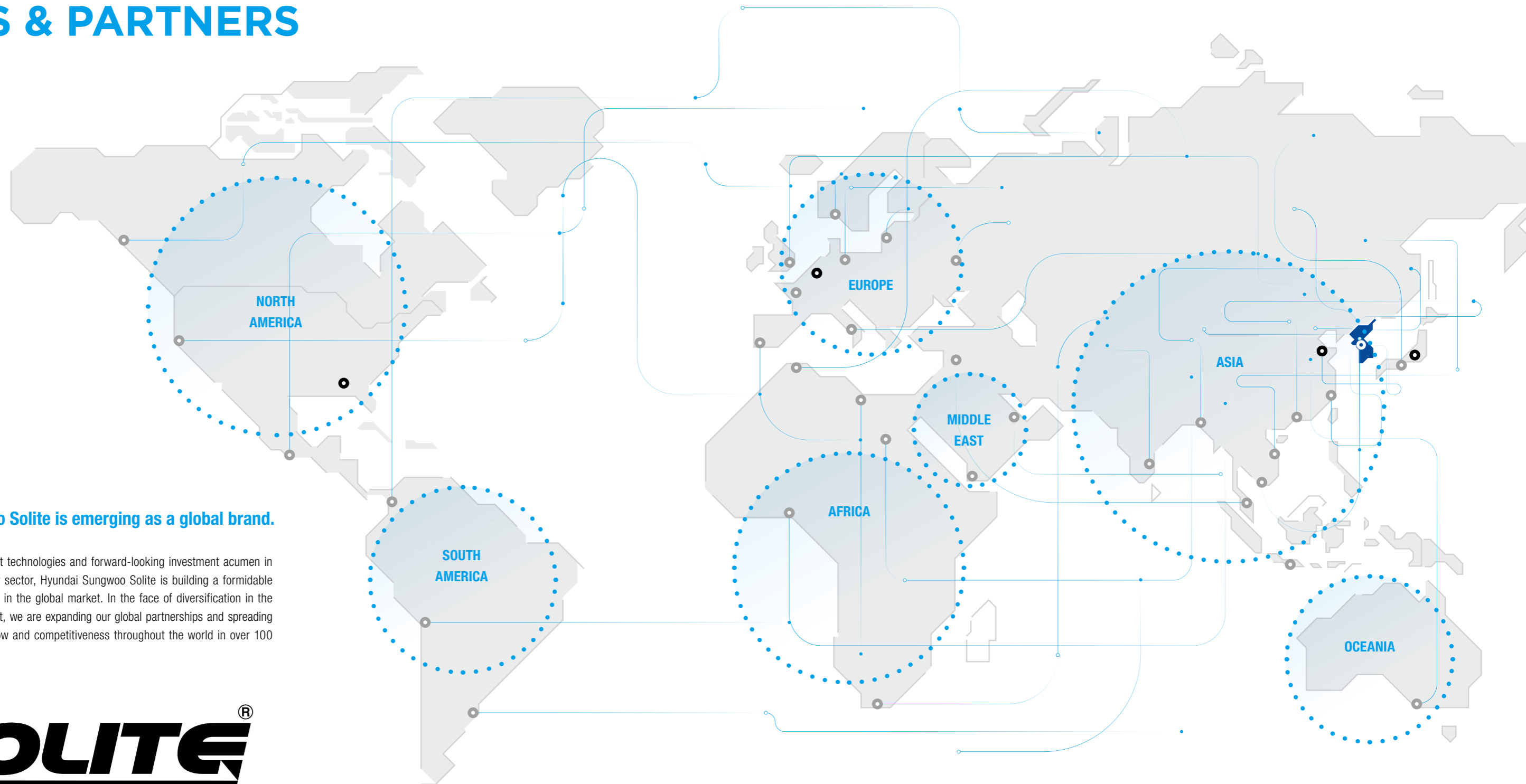

## Hyundai Sungwoo Solite is emerging as a global brand.

With expertise in the latest technologies and forward-looking investment acumen in the automotive technology sector, Hyundai Sungwoo Solite is building a formidable brand power in Korea and in the global market. In the face of diversification in the dynamic automotive market, we are expanding our global partnerships and spreading our technological know-how and competitiveness throughout the world in over 100 countries.

# **SOLITE**<sup>®</sup>



Exporting countries

More than **100**

# CORE COMPETENCE

In promise of a better battery,  
Hyundai Sungwoo Solite invests constantly  
in areas to improve quality and technology.  
By challenging the conventional, while  
respecting humanity, we will continue to  
satisfy customers and move forward.



HYUNDAI SUNGWO SOLITE CO.,LTD.

**SOLITE**<sup>®</sup>  
AGM TECHNOLOGY



# AUTOMOTIVE & COMMERCIAL BATTERIES

**We set the standard for automotive batteries with ideal product design and quality.**

Solite has become the standard of good batteries. We develop and produce automotive batteries of the highest quality and stability.

### CMF(Complete Maintenance Free) Series

A maintenance free product with unique Pb-Sn-Ca alloy applied. Ensures strong starting power even in extreme temperatures.

### EFB(Enhanced Flooded Battery) Series

A flooded battery type ideal for vehicles with an ISG(Idle Stop&Go) system. Offers improved charge acceptance and cycle life compared to conventional flooded type batteries.

### AGM(Absorbent Glass Mat) Series

Ideal for vehicles with an ISG(Idle Stop&Go) system, AGM series enable power driving through elevated durability compared to flooded type batteries.

### PT Series

Suited for trucks and construction equipments, this line provides stable power to tolerate vibration and shock.

### Heavy Duty CMF Series

An economical battery with excellent maintenance-free performance and excellent ignition safety.



- CMF Series



- EFB Series



- AGM Series



- PT Series



- Heavy Duty CMF Series



# INDUSTRIAL & MARINE/RV BATTERIES

**With strong power that withstand harsh industrial environments, we provide the pillars to various domestic and international industrial developments.**

Hyundai Sungwoo Solite is expanding its brand power and expertise to agricultural machinery, ships, and heavy industrial equipment and is renewing its strategic positioning as a partner and supplier for optimum energy to support a wide-range of cutting-edge equipments and facilities.

## Industrial Batteries

Solite is making a mark in the domestic and international industrial environment. Hyundai Sungwoo Solite provides top-performing maintenance-free batteries for state-of-the-art equipments in a fast-changing industrial environment. It is Hyundai Sungwoo Solite's priority to provide guaranteed industrial batteries with high quality and long lifespan.

## Marine Batteries

Even troubled waters cannot stop the power and endurance of Solite batteries. Designed to withstand the severest conditions in sea, Solite's marine batteries perform steadily and securely with high and consistent starting power. Storage performance has been strengthened by applying special alloy, and its long lifespan is one of its features along with the minimized probability of self-discharge during standby at port.

## RV Batteries

Solite Batteries for recreational vehicle(RV) meet various demands from engine starting to deep cycling service for electric application. These dual purpose batteries are the ideal compromise between high starting and extra reserve power for accessory loads.



- Industrial Batteries(SLD,SLX)



- Marine/RV Batteries



# MANUFACTURING PROCESS

**Hyundai Sungwoo Solite operates one of the world's best battery production line.**

At Gyeongju manufacturing plant, we develop innovative technologies fueled by our unwavering challenging spirit and creative thinking. Only the best products are produced through our strict quality testing processes.

**Plate Pasting Line - Paster**

Advanced steel belt type applicator with an improved orifice plate enables accurate weight application and flawless masking operations.

**Assembly Line - Strap Welder**

Differentiated from the existing intercell welding machine, our welding machine is operated using the hydraulic servo control valve system, enabling accurate gripping and welding essential to the vast improvement in battery quality.

**Assembly Line - Cover Sealing**

Unlike conventional covering devices, a 4-point measurement thermocouple temperature controller is utilized in our process, enabling fusion bonding to be performed at a more accurate temperature. Additionally, the Quick Change Die (QCD) System improves time-efficiency for exchanges of machine models.

**Assembly Line - Acid Filling**

Indicator level detection function, enabling quick and accurate liquid injection, as well as sulfuric acid injector with a suction function are used in this process.

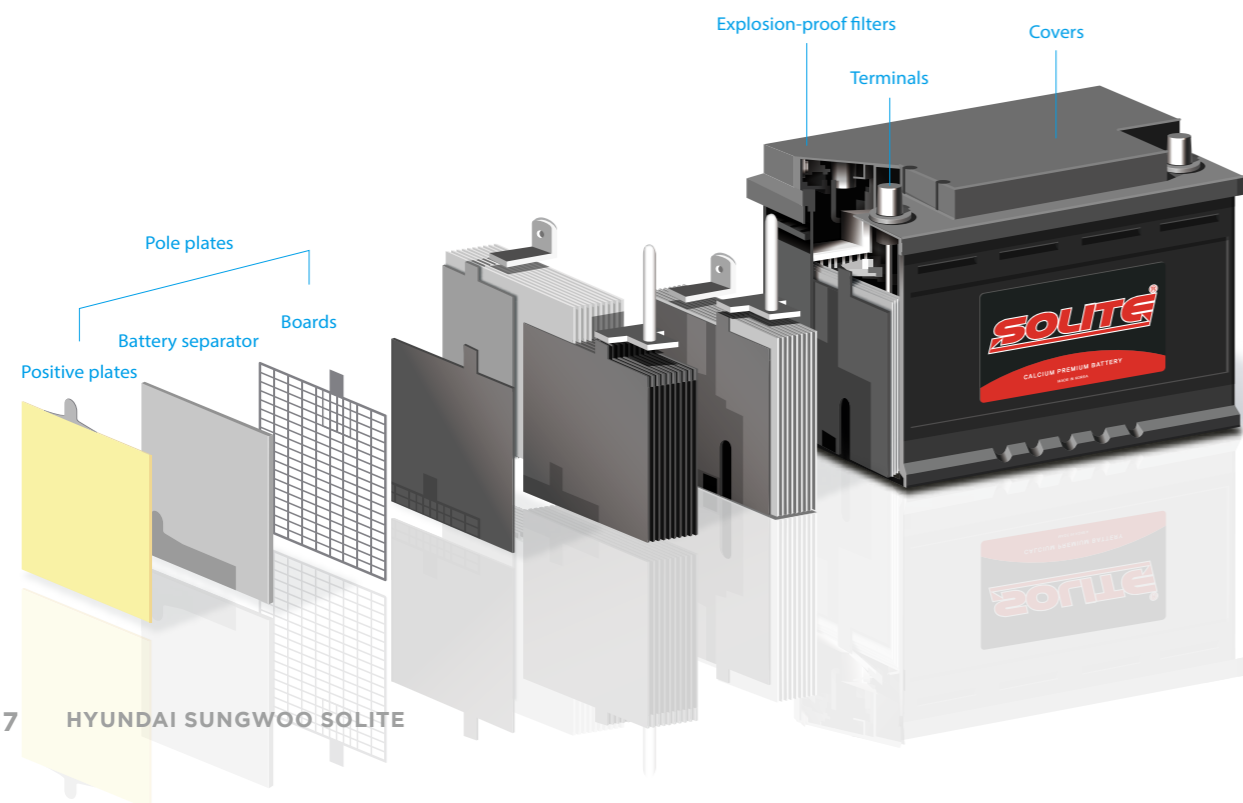



Endless pursuit for detail and safety, even of the unseen.  
Hyundai Sungwoo Solite's pursuit for a better battery creates the optimal process system.

1. Manufacturing Line

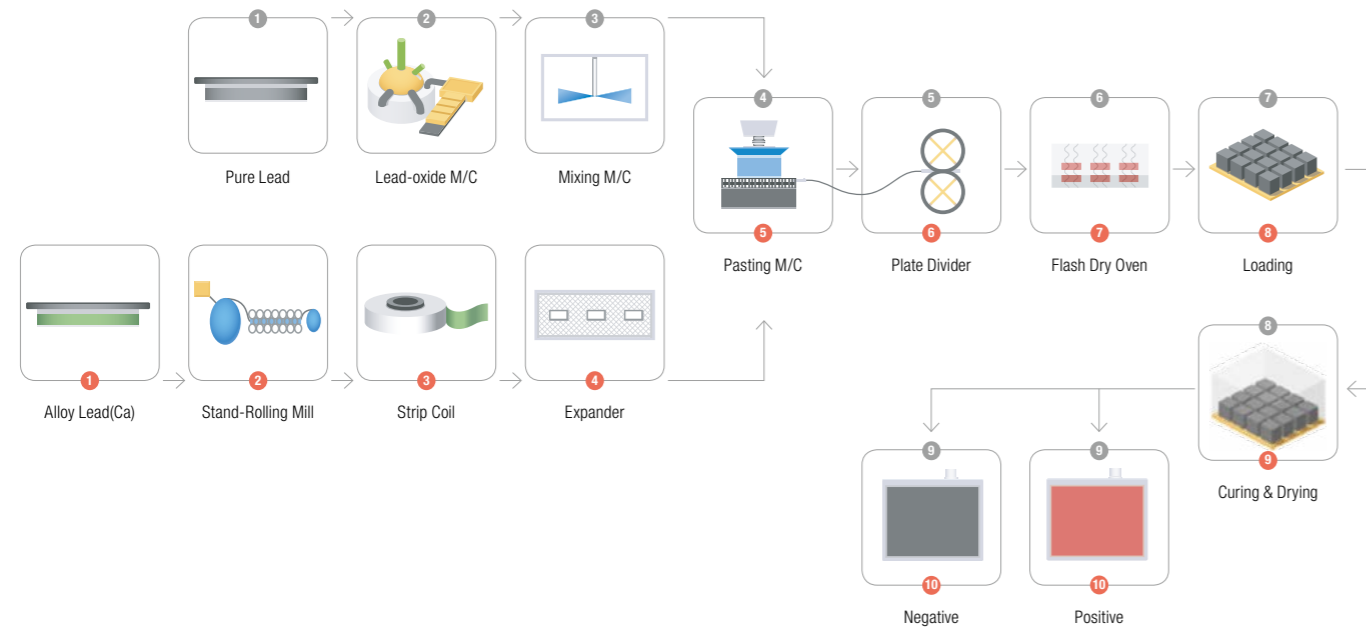

2. Part Assembly Line

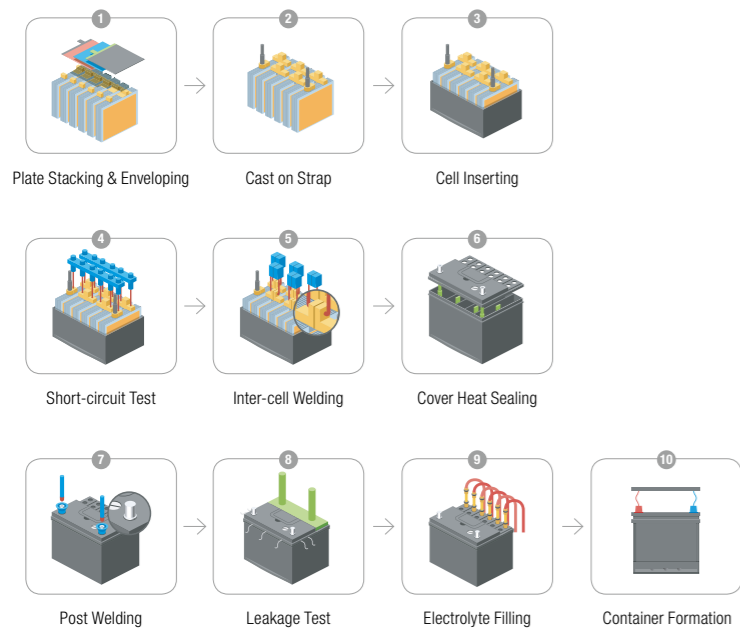

3. Final assembly Line

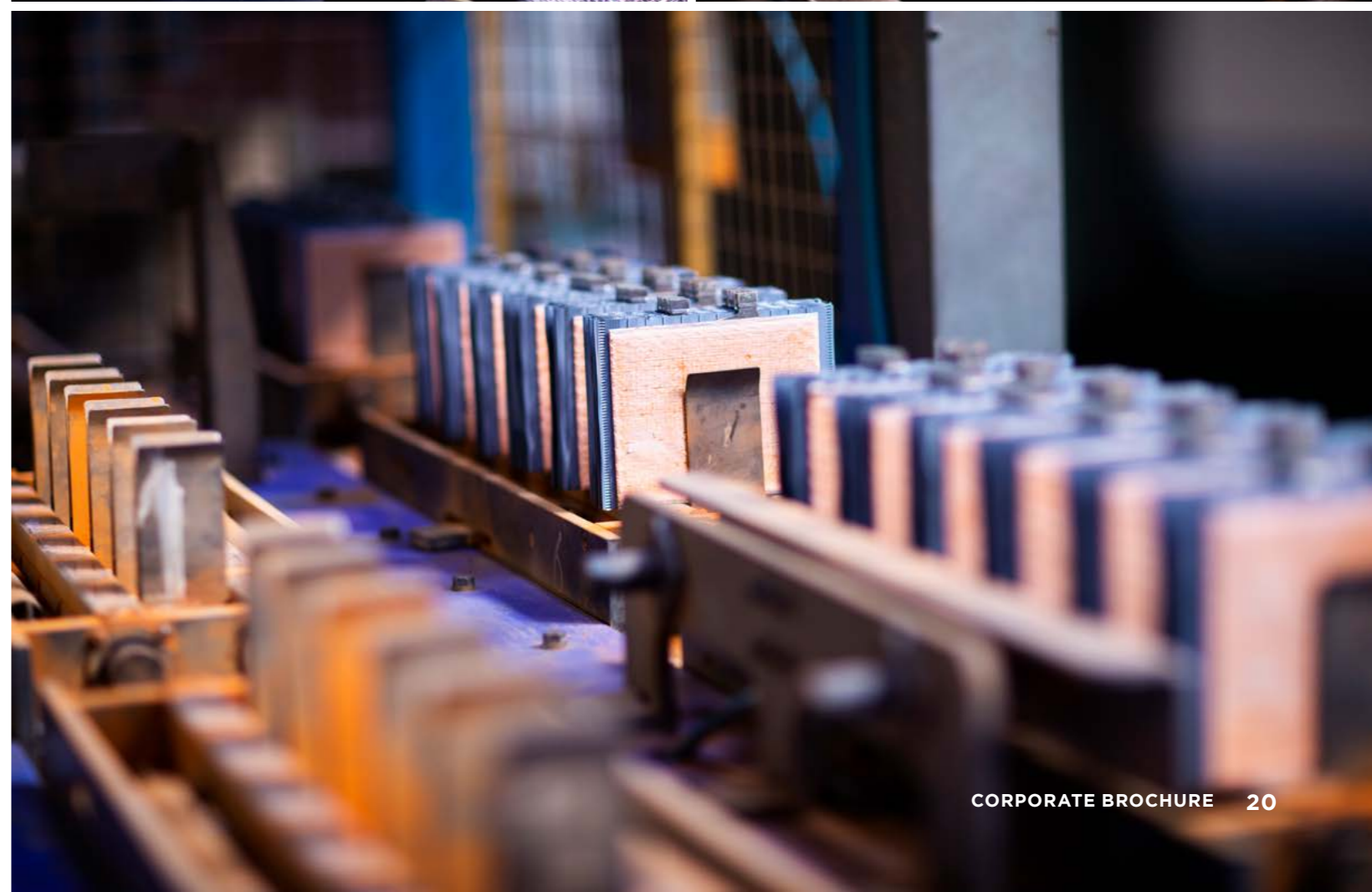
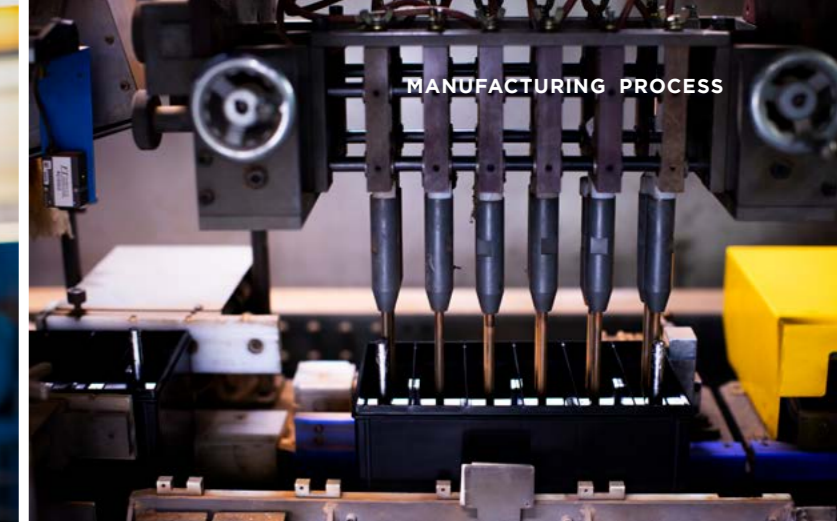
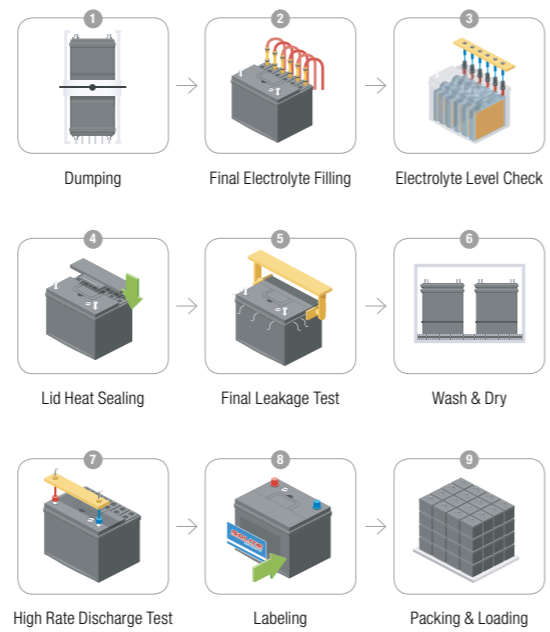







# RESEARCH & DEVELOPMENT

**We prepare for the battery industry of the future with advanced technological innovation.**

With expanded product lineup of 155 types and 789 items through continuous technology development, Hyundai Sungwoo Solite continues to challenge toward making better batteries. For a safer and more convenient automotive experience, we strive to become a solid supporter in the all-round industry, to strengthen the competitiveness of mass-produced products, and develop advanced technologies to pioneer the future of the global automotive battery industry.

- A Development of New Materials**
  - Development of special alloy to improve corrosion resistance
  - Research on improving the use of high-density active materials to maximize lifespan
  - Development of additives to improve operation
  - Development of design techniques for product stability
- B Development of New Products**
  - Strengthening competitiveness through product line diversification and quality improvement
  - Development of high performance and lightweight product
  - Development of industrial battery with prolonged lifespan
  - Research and development of electric vehicle battery(lithium-ion battery)
- C Development of Production Technology**
  - Development of optimized process, lines, and product design
  - Production system to reduce manufacturing cost and improve productivity
- D Quality Testing**
  - Conduct quality tests at each process
  - MS testing: weatherproof test, complex environmental test, vibration test, synthetic lead analysis, viscosity measurement, moisture content measurement

**Standard Certification**

		
ISO 14001	IATF 16949	ISO 45001
		
Environmental Labeling Certifications	Product Certifications KS C 8504	Product Certifications KS C 8518

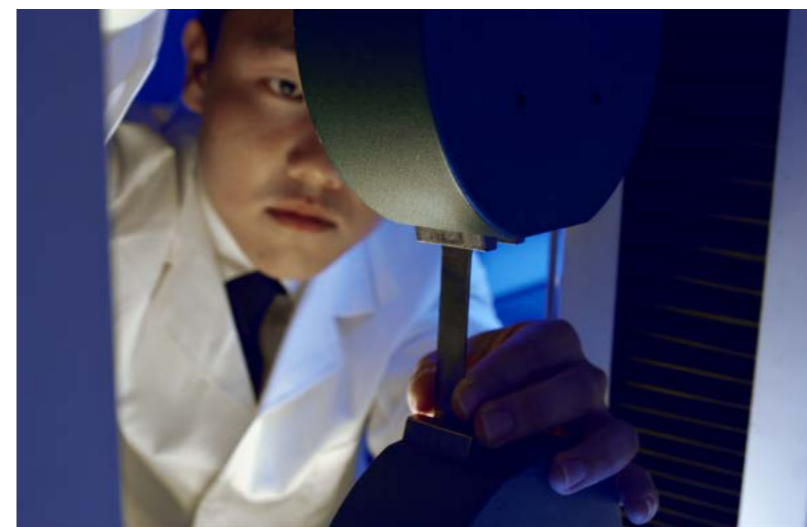
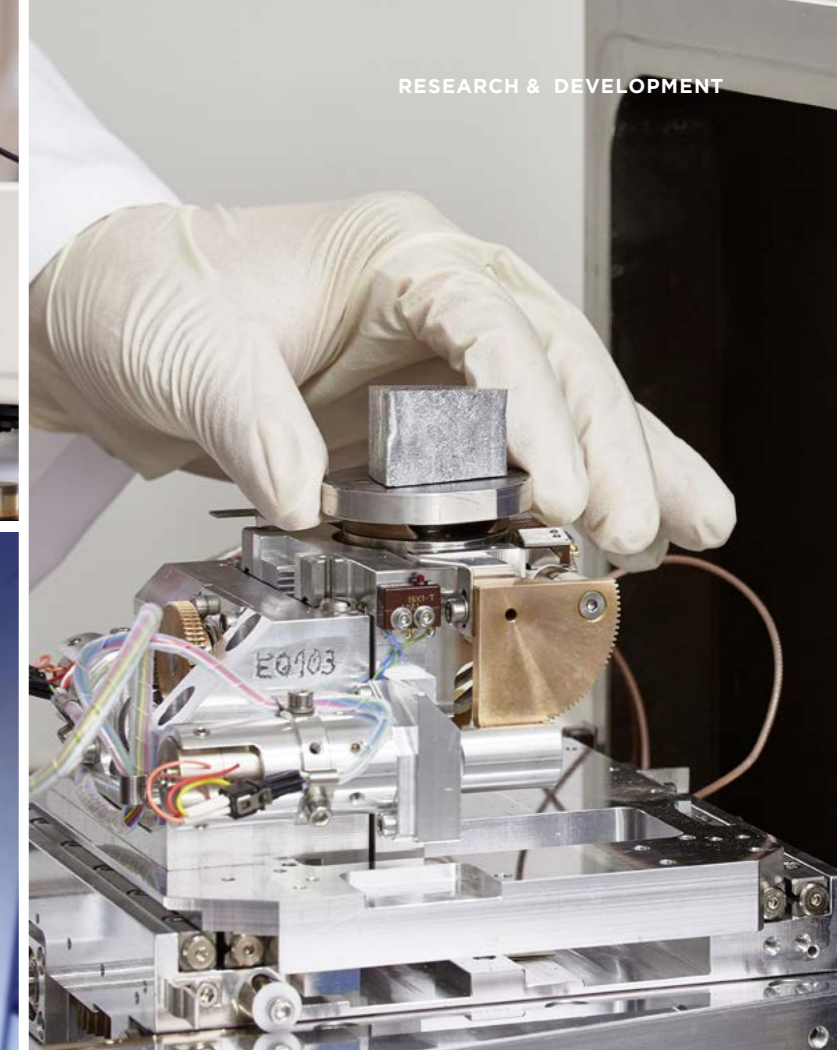
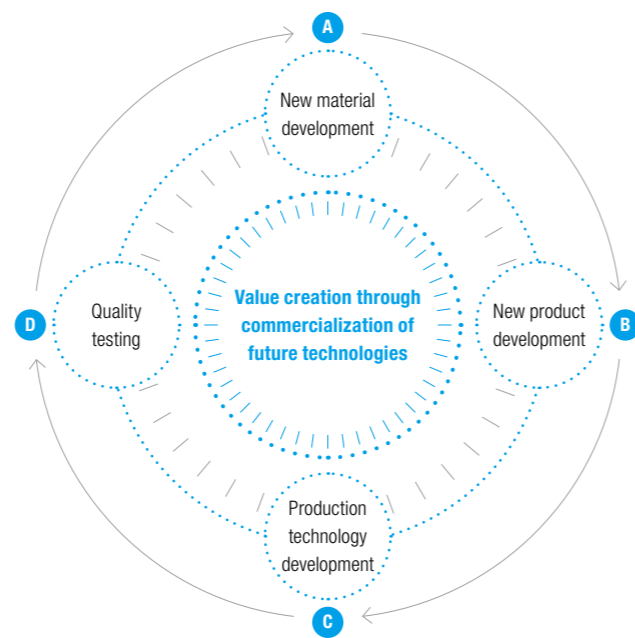

# MOTORSPORTS

Since its foundation in 1997, Solite Indigo Racing has put Hyundai Sungwoo's technique at test and challenging spirit to action.



## SOLITE INDIGO RACING

Solite Indigo Racing is a professional motorsports team well-regarded in Korea and now expanding its wings globally. With diverse know-how accumulated over many years in race car manufacturing, technology development and systematic data management, Solite Indigo Racing has achieved overwhelming victories in various series. Within only two years of debut in the international series in 2018, Solite Indigo Racing became champion of the 2019 Blancpain GT World Challenge Asia and the first Korean team to compete in the renowned Macau Grand Prix - FIA GT World Cup. Solite Indigo Racing team promises a bright future along with Hyundai Sungwoo's technological advancement and innovations.



### Racing History

- 1997** • Founded Indigo Racing Team
  - Overall 3rd in 'KMRC' Formula 1800 class
- 1998** • Overall 3rd in 'KMRC' Formula 1800 class
  - Overall 4th in 'KMRC' Touring A/B class
- 1999** • Overall 3rd in 'KMRC' Formula 1800 class
  - Overall 3rd in 'KMRC' Touring A class
- 2000** • Overall 3rd and 4th in 'KMRC' GT class
  - Overall 2nd and 6th in 'KMRC' Formula 1800 class
- 2001** • Overall 5th and 6th in 'KMRC' GT class
  - Overall 2nd and 8th in 'KMRC' Formula 1800 class
- 2002** • Overall 1st and 2nd in 'BAT GT Championship' GT1 class
  - Overall 1st and 2nd in 'BAT GT Championship' Formula 1800 class
- 2003** • Overall 1st and 3rd in 'BAT GT Championship' GT1 class
  - Overall 1st and 4th in 'BAT GT Championship' Formula 1800 class
- 2004** • Overall 1st and 4th in 'BAT GT Championship' GT1 class
  - Overall 3rd and 5th in 'BAT GT Championship' Formula A class
- 2005** • Overall 2nd and 3rd in 'BAT GT Championship' GT1 class
- 2006** • Overall 2nd in 'BAT GT Championship' GT1 class
- 2009** • Overall 1st and 3rd in 'CJ O SuperRace' Super 3800 class
  - Overall 2nd and 4th in 'CJ O SuperRace' Super 2000 class
- 2010** • Overall 1st in 'KMGF' GT class
  - Overall 1st and 2nd in 'KMGF' Genesis Coupe class
- 2011** • Overall 1st and 2nd in 'KSF' Genesis Coupe class
- 2012** • Overall 1st and 3rd in 'KSF' Genesis Coupe class
- 2013** • Overall 2nd and 5th in 'KSF' Genesis Coupe class
- 2014** • Overall 1st and 4th in 'KSF' Genesis Coupe 10 class
  - Overall 1st and 4th in 'KSF' Genesis Coupe 20 class
- 2015** • Overall 3rd in 'KSF' Genesis Coupe 10 class
  - Overall 1st in 'KSF' Genesis Coupe 20 class
- 2016** • Overall 1st in 'CJ SuperRace' GT1 class
- 2017** • Overall 2nd in 'CJ SuperRace' GT2 class
- 2018** • Overseas debut - Participated in 'Blancpain GT Series Asia'
  - Overall 1st in 'TCR Korea'
- 2019** • Overall 2nd and Drivers' Champion in 'Blancpain GT World Challenge Asia' GT3 class
  - Overall 2nd in 'TCR Asia'
  - First Korean team to race in 'Macau GP - FIA GT World Cup', 1st in GT3 Silver class



# EXPANDING OUR STAR

Like a ray of sunlight  
blossoming life,  
Like a beam of starlight  
shining hope,

Towards a more powerful  
and reliable energy,  
Hyundai Sungwoo Solite aims for higher  
challenges and greater innovations.

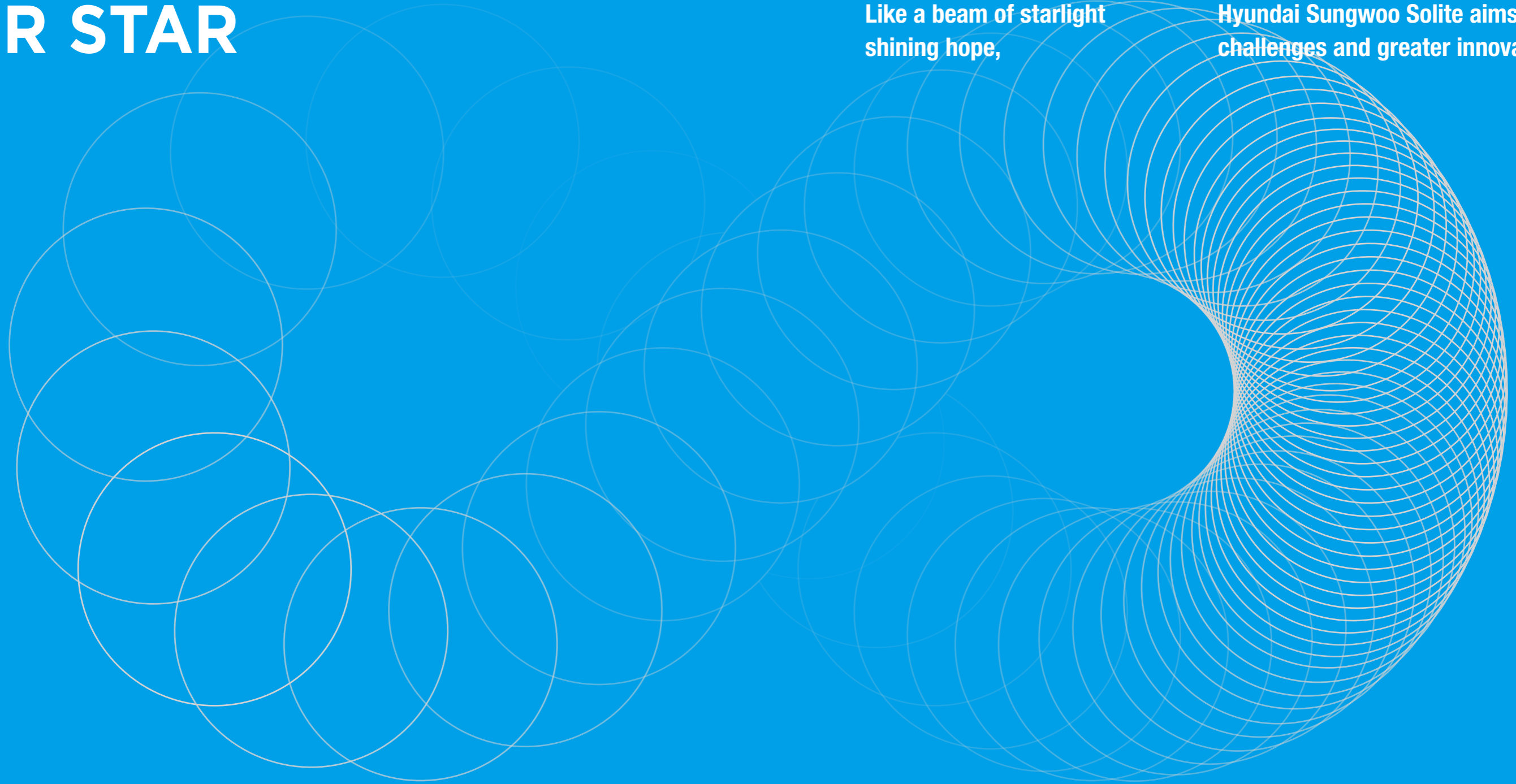



**HYUNDAI SUNGWO  
SOLITE**

**Hyundai Sungwoo Solite Co., Ltd.**

Hyundai Sungwoo Holdings Building, 609 Bongeunsa-ro,  
Gangnam-gu, Seoul South Korea